



## Transition from Detached Plazas Close to Traditional Bazaars towards Reviving Lost Spaces Close to Contemporary Shopping Centres, Case Studies: Proma Shopping Center and Bazaar-E Reza in Mashhad

Shahab Abbaszadeh<sup>1\*</sup> and Hamid Gohari<sup>2</sup>

<sup>1</sup>Ph.D in Architecture, Department of Architecture, Faculty of Architecture and Urbanism, Hakim Sabzevari University, Sabzevar, Iran.

<sup>2</sup>M.A. Student of Urban Design, Faculty of Urban Design, Zanjan Branch of Azad University, Zanjan, Iran.

Received 26 January 2013;

Revised 25 June 2013;

Accepted 11 August 2013

**ABSTRACT:** In traditional Bazaars social interactions, parallel to economic and movement interactions, created a mixed urban space which was dynamic, lively and attractive to the audience. However, modern shopping centers and shopping malls are economy focused and void of variety of urban spaces like traditional bazaars. The presence of public open spaces and urban squares undetectable from traditional bazaars – called lost space in modern commercial centers – play a great role in supporting citizens' social relations and interaction, resulting in the increase of social capital. This research focuses on two case studies – Bazaar-e Reza and Proma shopping center – in Mashhad. Therefore, the present article using analysis of the rigorous literature review, by presenting extracted theoretical framework in order to recognize influential constructs in supporting citizens' social interactions in traditional Bazaars. Since in this research, a mixed – method was used, finally to examine validity of the research and also gaining citizens' ideas, a questionnaire survey was applied toward utilizing inferential statistic – structural equation modelling by LISREL software. The results of this research reveal that the two spatial-aesthetic and functional constructs play pivotal roles in supporting citizens social interaction. In this regard, vitality and access – linkage as factors of spatial-aesthetic construct and inclusiveness and personalization as factors of functional constructs played main role towards supporting citizens social interaction. Finally the results of this study can be utilized in the formation of urban plazas in today's commercial centers to provide a suitable context for increasing the social capital level in structure of public open spaces in the city.

**Keywords:** Social Interactions, Social Capital, Lost Spaces, Bazaar, Commercial Centers, Urban Plaza.

### INTRODUCTION

Various forms of social interaction are essential for the increase of the level of social capital in the structure of public open spaces, in cities (Pourjafar, 2010). Urban plazas, constructed at the entrance of commercial centers are among the public places influential on the urban social life, places where the foundation of social interaction is laid. Traditional urbanization utilizes such urban spaces in a way that the formation of the hierarchy of space exhibits desirable qualities, inside and outside of Bazaar.

In terms of functionality, they maintain a unique identity which serves as a stage for the formation of spatial and social interactions as capital-maker spaces (Soltanzadeh, 2007). Today, the dominance of the modernist approach in urbanization has shaped commercial spaces into imported designs, alien to Iranian culture and society. The inability of such spaces in providing the qualities necessary for the formation of this kind of social interaction turns them into what is termed lost spaces, necessitating their revival by returning the required qualities.

Backed by the analysis of a rigorous literature review, the present article attempts to offer a theoretical framework on the subject in the form of a position paper. Considering that this is a qualitative research, following

\*Corresponding author email: Shahab.arch@gmail.com



the data collection stage, which is carried out using the quantitative technique of questionnaire survey, the article makes a comparison between the theoretical framework extracted from the literature review and the data collected from the questionnaires in order to establish the validity of the information. In other words, this study attempts to analyse the Plazas of commercial centers as a foundation for the formation of social interactions through an analytical and multi-dimensional approach, while following the stages of their evolution from the square of traditional Bazaars as a capital maker space to the Plazas of modern commercial centers as lost spaces in cities today. After identifying the spatial – aesthetic and functional qualities, affecting social interaction in the past and present, two commercial spaces in Mashhad (Bazaar-e Reza and Proma shopping center) are studied closely. The results of this study can lead to effective solutions for the restoration of such spaces to capital-maker spaces in the structure of the today cities.

#### **URBAN SPACES AS A FOUNDATION FOR THE FORMATION OF SOCIAL CAPITAL**

Based on the existing theories regarding the concept of social capital, it is not merely a materialistic approach and it does not appear in individuals but rather in their interactions with each other (social interactions) (Bullen & Onyx, 1998). Social interaction is a kind of group behaviour which lays the foundation for social capital. In this regard, Homans (1974) state that social groups share some kind of mutual feeling, in other words, more interaction among group members creates more interest in them and their environment. This in turn is followed by an increase in social capital. As a result, one can assume that social interactions are the prerequisite for the formation of social capital.

In order to meet this need, it seems necessary to create the required spaces for such activities, so that the two factors of behaviour and environment, can meet citizen's needs through interaction. As the public aspects of the city, urban spaces are among these. An investigation of the existing theories in various fields regarding urban spaces reveals that if a space is considered public, its ownership or access rights can not hinder its function as a public place and therefore social interaction can occur in that area. In the positivist approach, urban spaces include urban areas that are intended and equipped for the purpose of public utilization and participation in group activities and social interactions. (Goodsell, 2008). Therefore, public spaces are open urban physical places which appropriately function with public utilization and

social interaction. Streets, sidewalks, parks, beaches, rivers, squares and urban plazas are all necessary for the increase of social interaction and encounters.

In the next stage, the article continues with the analysis of Bazaars and the related areas as influential urban spaces in the structure of traditional cities. There will be especial emphasis on its capital-maker aspects (social capital) with regard to the basic spatial – aesthetic and functional structures.

#### **BAZAARS, CAPITAL-MAKER SPACES IN THE STRUCTURE OF TRADITIONAL CITIES**

The word Bazaar comes from “Vachar” in Pahlavi language and “Abakari” in Achaemenid, a compound word consisting of “Aba” which means a place of gathering and “Kari” that means grazing and roaming. In middle Persian, the word “Vazar” was common, in which the suffix “Zar” generally means a place of trade in Dari Persian (Movahed, 2005).

The concept of Bazaar, in the sense it is currently understood in Iranian cities, as a social-economic institution, was first formed in Sassanid era and thereafter it became one of the essentials of every Iranian city, so that it was sometimes built even before the construction of residential neighbourhoods (Habibi, 1996). From the Seljuk era onwards, we can witness the flourishing of urban Bazaars in Iran. In the Safavid era it reached its pinnacle under the influence of the existing security and the development of foreign relations and commercial exchange (Soltanzadeh, 2001, pp. 21-22). This prosperity reached a point where the concept of city acquired other concepts such as “City- Bazaar” and “City-capital”. The most important features of traditional Bazaars before the arrival and dominance of modernism in Iranian cities (the beginning of Qajar era) can be best investigated and analyzed in spatial-aesthetic and functional areas. This will furnish a good understanding of the existing social capitals.



## Exploring Spatial - Aesthetic and Functional Features

### Spatial- Aesthetic Features

Bazaars were regarded as one of the pivotal elements of traditional cities' infrastructure; they were the backbone and the heart of the city. A range of urban spaces were present in the structure of Bazaars, most important of which are Mosques, Baths, Charsogh, Caravanserais, Zurkhaneh, Squares and etc (Naghizadeh, 2010). The positioning of these spaces with their numerous functions in the structure of the Bazaar and their close proximity to one another resulted in the formation of the three main features of Iranian traditional Bazaars: it was multidimensional, logical, continuous and coherent. These features combine to build a harmonious, balanced and continuous system which can create a sense of unity despite diversity. Therefore, it is important to see Bazaars as mega-scale urban spaces consisting of smaller spaces that underlie the formation of social life and act as the main platform for the creation of social capital in urban structure.

### Functional Features

There are numerous contributing factors involved in turning Bazaar into the most important sociocultural arena with formal, functional, economical and etc. a place where individual and group relationships acquire a unique identity. In urban spatial structure, Bazaars were places for the transfer and dissemination of information, hosting national and religious festivals and ceremonies, an arena for the flow of goods and capitals as well as protests and political advertising (Falamaki, 2005). In fact, bazaar was considered a symbol of group and local consensus and integration for the purpose of participation, solidarity and social trust (Pourjafar, 2010, p. 150). Therefore, Bazaar was the most important urban structural element, both in political-economic and sociocultural sense and it has always contributed to the urban functional features (Falamaki, 2005).

As a general conclusion, the analysis of the spatial-aesthetic and functional features of Bazaar with regard to the level of social interaction and social capital can be presented in the form of the Fig. below (1). It can also be stated that by integrating a hierarchy of local and regional roles, Bazaar is a place for a balanced realization and formation of governmental, commercial and social functions as well as official services (Fig. 1). This is how to follow and analyze the story of an Iranian city.

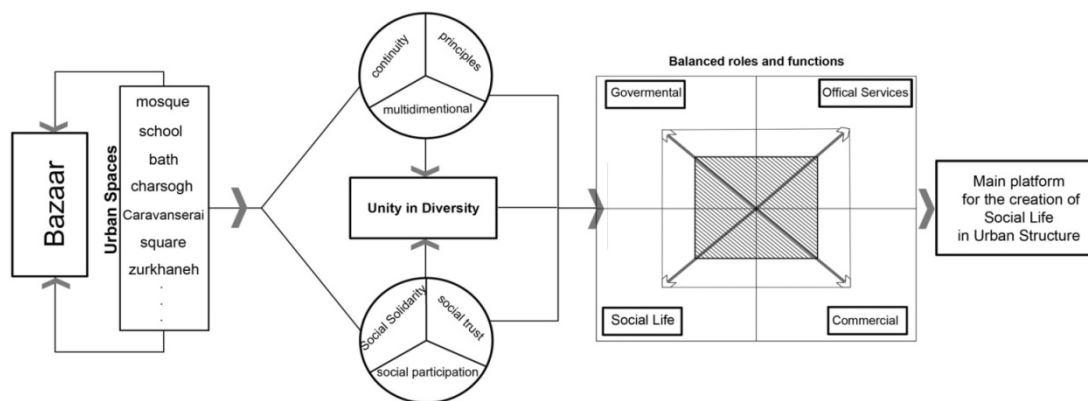

Fig. 1. Traditional Bazaar, the Main Platform for the Creation of Social Life

Here we continue by the analysis of Bazaar squares as one of urban spaces present in the structure of the city, so that we can understand its spatial-aesthetic and functional features and qualities.

### Features and Qualities of Bazaar Squares

Iranian traditional Bazaars can in fact be considered as mega-scale urban spaces consisting of smaller spaces which act as platforms for the formation of social interaction, places where social, cultural and political functions exist alongside the economical function. Inside



or adjacent to some of these Bazaars, there were open spaces called “squares” where daily, periodic or seasonal markets were held along with occasional religious, political or dramatic events (Pakzad, 2007, p. 533). Here we discuss some of the most important spatial-aesthetic and functional features and qualities of Bazaars:

### *Spatial-Aesthetic Features*

Bazaar squares are one of the most important elements of the spatial structure of Bazaars (Bardianamoradnejad, 2011). In terms of spatial qualities, they had a significant role in the formation of spatial hierarchy between the inside and outside of Bazaar; a hierarchy which in addition to encouraging the customers to participate in various activities, sets specific limits and guidelines for it. In terms of the architectural aesthetics and style of the urban design, the squares showcase unique features as well as perfect harmony and coordination with the space inside the Bazaar. Considering the complexity of the environment, this emphasis on the human aspects of the structure makes it understandable and customer-friendly. Perhaps Naghsh-e Jahan square, Isfahan, is a perfect example of such features, where spatial relationships are so dynamically developed that create a deep sense of public space capable of guiding citizens and fulfilling their needs for space and identity (Ardalan, 2010, p. 153).

### *Functional-Aesthetic Features*

From this perspective, the structure could promote values and coordinate behaviours through defining diverse and unique functions. They in turn could create identity and increase the emotional investment of the residents. Squares of traditional Bazaars had a pivotal role, since they could provide the space where many of the citizens’ group activities were performed, activities which could improve the level of social interaction and strengthen social networks. Among such activities were mourning rituals, festive events, appointments, promotions and etc. As an example, by positioning the religious spaces located in the vicinity of the main entrances (Naghsh-e Jahan square), the Isfahan Bazaar has been successful in creating a spiritual atmosphere, promoting moral and religious values, especially in business and social interactions. From the social point of view, due to the presence of places such as mosques and other social spaces, gatherings, celebrations and holiday events attracted a large number of people. On the other hand, the presence of commercial spaces located in the square is a reminder of the economic values of the space. The existing architecture and urbanization style, derived from the Isfahan school, provided the ideal spatial values capable of strengthening the sense of space as well as creating a valuable environment for participation and social interaction (Fig. 2).

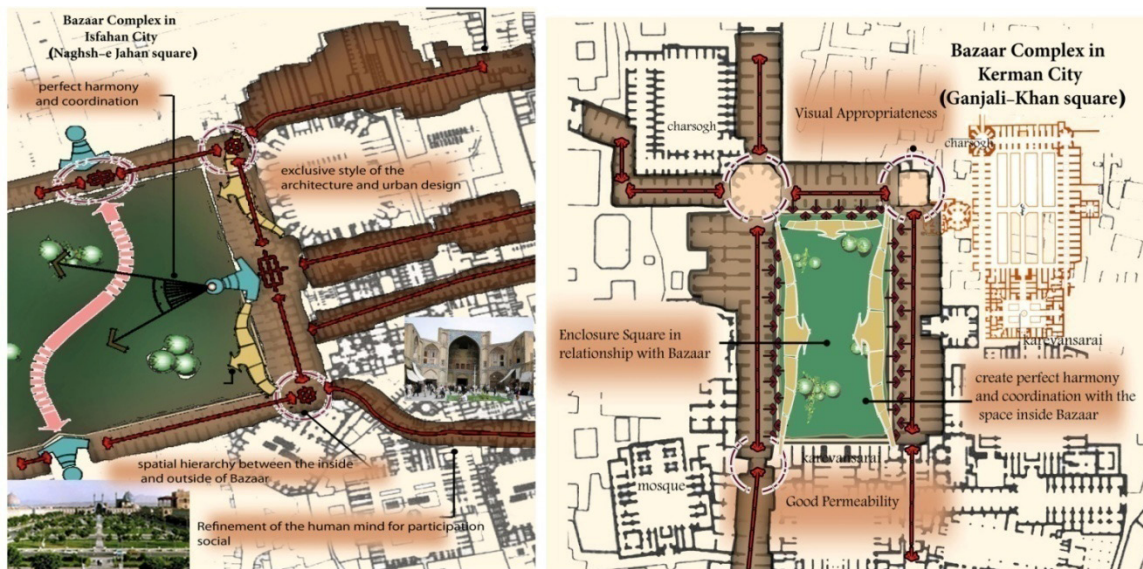

Fig. 2. Naghsh-e Jahan and Ganjali-Khan Squares in Traditional Bazaar Structure





The most important physical factors influencing perception and sense of place consists a degree of enclosure, contrast, proportion, human scale, distance, texture, colour, smell, sound and visual diversity. Features such as identity, history, imagination and fantasy, mystery, security, vitality and memory also contribute to the establishment of a focused relationship with the sense of place. The construction of these factors is based on the semantic structures of the space and environment and they influence the formation of sets of particular qualities (Steele, 2007). In terms of the functional-semantic and aesthetic qualities, traditional bazaars have been able to successfully create a sense of place proportionate to the environment and society.

Considering the important structural features of Bazaars, the most important qualities of squares, as urban capital-maker spaces, from spatial-aesthetic and functional perspectives include: coherence, spatial hierarchy, human scale, Visual appropriateness, functional variety, compatibility and a sense of identity (Fig. 3). These qualities act as an effective platform for the promotion of values, rituals and cultures of a society for the purpose of enhancing social interaction, urban life and eventually social capital. Fig. 3 offers an analysis of the discussed issues. In the next step, we concentrate on the transformation process of such spaces in the contemporary era.

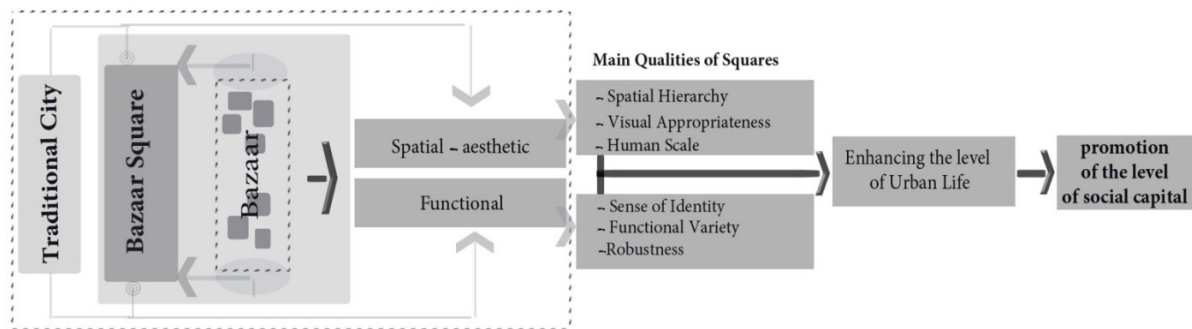

Fig. 3. Analytical Diagram of the Bazaar Square in a Traditional City

### CONTEMPORARY ERA, DEMISE OF THE CONCEPT OF BAZAAR AND THE FLOURISHING OF MODERN SHOPPING CENTERS

Throughout the 19th century and in the beginning of 20th century, the urban context and spatial structure didn't differ much from the Safavid period; Bazaars were still pivotal and served as the backbone of the city. They balanced roles and functions in governmental, commercial and official services, as well as the social life. However, when the Pahlavi regime came to power, social spaces, such as streets, were rebuilt based on the modernist school and began to incorporate new concepts in the structure of traditional cities. In addition to transferring a major part of economic activities to streets, Bazaars were weakened and the concept of the "Bazaar -Place" was changed into the "Bazaar- Time". Streets, as their major rivals, became the main source of the distribution of goods and services in the structure of cities. Squares,

too, lost their ancient meaning and their spatial-aesthetic and functional concepts took a different form. The most significant difference is changing the traditional spatial elements of Bazaars and mosques to modern elements such as banks, post and telegraph offices (Habibi, 1996). On the other hand, lack of interest in and restoration of Bazaars and related spaces, especially squares, resulted in the fading or even elimination of such spaces (Soltanzadeh, 2010). In the contemporary era, changes and developments of Bazaars and their squares, as part of the urban spatial structure, can be discussed in light of four historical periods, when Bazaars and squares underwent fundamental changes and faced the decline of social capitals, gradually turning into lost spaces. In contrast, supermarkets, passages and modern shopping centers thrived, but this prosperity manifested more in commerce and services rather than social aspects.

Meanwhile, Bazaars' squares which maintained a logical relationship with the context of the city and gave them a unique identity, disappeared in the structure of



modern shopping centers. Today, modern streets act as the entrance of shopping centers and the relationships among pedestrians is turned into an encounter between pedestrians and vehicles (NaghiZadeh, 2010). Private and public spaces are immediately connected and they have no limitations. In the meantime, opportunities for maintaining any kind of social interaction are minimized

and consequently the transference of values and culture is hindered, resulting in the decrease of social capital.

In this regard, we continue with the analysis of the concepts related to modern shopping centers with an emphasis on the role of urban plazas as public spaces in the urban structure, compared with traditional Bazaars and squares.

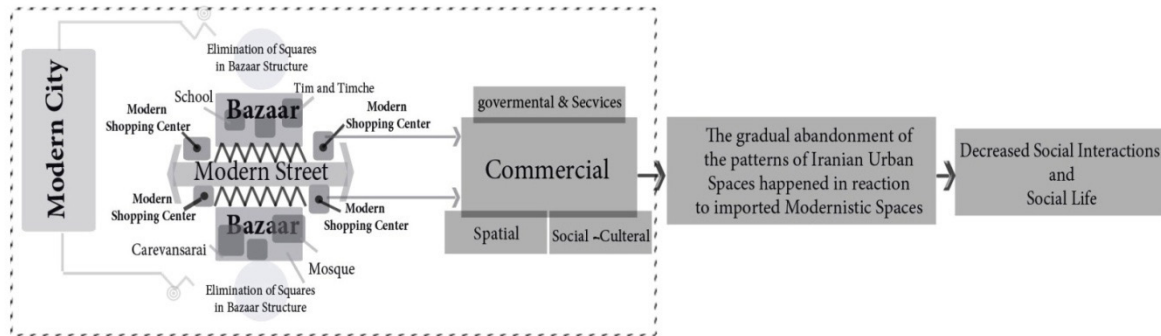

Fig. 4. Analytical Diagram of the Bazaar in Modern City

### DETACHED PLAZAS OF MODERN SHOPPING CENTERS AS LOST SPACES OF CONTEMPORARY CITIES

Modern shopping centers are constructed based on a common pattern consisting of three major types of spaces including the detached entrance space, the central communicational space and the peripheral space (Soltanzadeh, 2010). Generally, based on the typology of urban spaces, Marcus (2008), the detached entrance spaces are categorized as “public spaces of building Complexes which are somehow reminders of the concept of urban plazas. This type of space is based on the relationship between private and public gains. The respective roles and functions determine the way individuals can benefit from them (Madanipour, 1996, p. 221). In comparison with the great Bazaar’s squares, they can serve as spaces with high social life and social capital. Bazaars employed such spaces based on the qualities of the traditional architecture and urbanization schools such as constructing spatial hierarchies, human scale and etc. This is what we can hardly find in immediate plazas of modern shopping centers in the contemporary era. Instead, we have deserted such spaces and they are left out of the circle of public activities for one reason or another. In other words, now we have “Lost Spaces”. Generally speaking, the principle reasons for the fading

of the role of detached plazas from modern shopping centers in the urban social life can be described as the following:

- Increased vehicle traffic
- Following modernism means unrestrained construction of open spaces and in the area.
- Ignoring social patterns, functional variety and mixed usages
- Lack of commitment and respect for public spaces from private and governmental organizations.

The mentioned reasons can be concluded with the point that although such spaces have specific functional and qualitative definitions, they have been unable to act compatible with the existing functions. Consequently, despite having great values and potentials we consider them as lost spaces. Roger Trancik’s (1986) categorization divides such lost spaces into spatial-aesthetic and functional dimensions. The reason for the existence of such lost spaces is the lack of a proper definition for private and public spaces along with the loss in function and meaning due to weakness in the utilization of traditional identity values (such as the elements present in traditional bazaar spaces) and hidden spatial values (such as heavy pedestrian presence (Fig. 5).

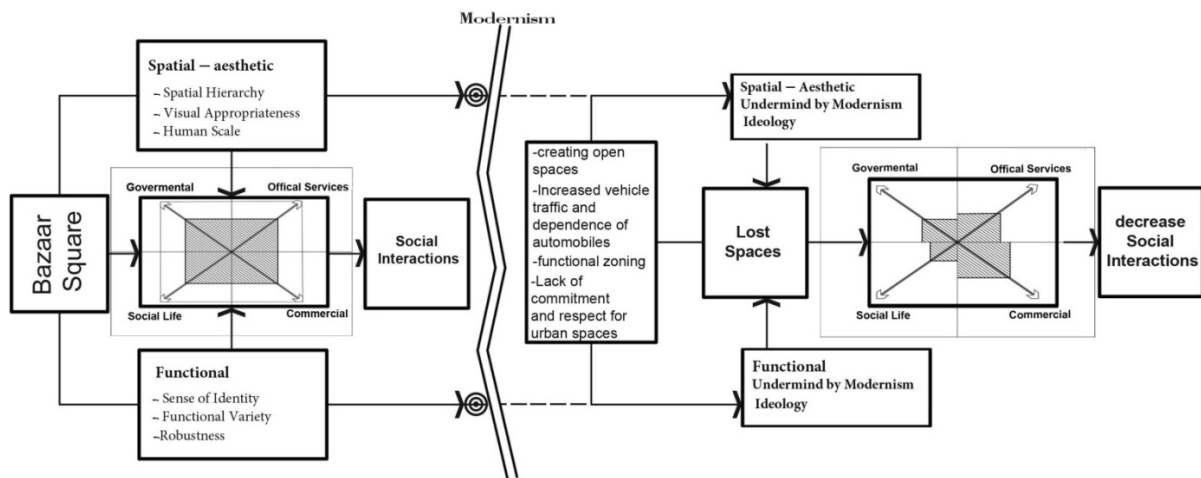

**Fig. 5. Analytical Diagram of Contributing Factors in The Removal of The Detached Entrance Plazas of Modern Shopping Centers (Lost Spaces)**

Considering our discussion regarding the current condition of immediate plazas of shopping centers, classified as lost urban spaces, it is important to analyze some of the spatial- aesthetic and functional qualities which make the formation of spaces with high social interactions and high capitals possible. At this point we continue with the analysis of the qualities and features of immediate plazas from the view point of scholars and experts.

***Desirable Qualities in Plazas of Modern Shopping Centers***

Miller (1998) believes shopping centers are somehow public squares in the modern capitalist society and the identity and experiences of citizen are formed in the various cultural forms of modern capitalism, i.e. shopping centers. The studies made on the universal experiences concerning the design of commercial centers reveal the special attention devoted to the design of detached entrance plazas so that they can act as a platform for desirable social functions such expression of opinions, cultural and identity values, social solidarity and social interaction. Such spaces should exhibit balanced formal, functional and meaning qualities and the more balanced they are the better their quality will be. The investigations of Gordon Cullen (2012) regarding the relationship of mass and space in streets and squares and his emphasis on town landscape, Jean Jacobs’ (1992) support of the differentiation and heterogeneity of the use of urban spaces, Cooper Marcus(1997) and William Whyte’s

(2001) definition of the importance the connection between space, people and urban public spaces, Kevin Lynch’s (1993) emphasis on importance of image in the formation of space, Michael Sorkin (2011) and Ian Bentley’s (2008) designing instructions and principles for urban spaces and Christian Norberg Schulz (2000), David Canter, John Punter (1991), Robert Venturi (2008) and Matthew Carmona’s (2010) consideration of meaning, aesthetic and memory dimensions of urban spaces, are all attempts in pursuit of ways for designing urban spaces with higher qualities. As an example, in their book “the design dimension of planning” Carmona and Punter (2011) introduce elements such as characters, view corridors, density, scale, accessibility, height, safety and noise as the most important qualities of the design of urban public spaces. Pakzad (2007) puts forward the 7 qualities of beauty, unity, identity, harmony, order, durability, stability and variability as the most important “general expectations” of urban spaces. According to him, provided that these spatial qualities and expectations are met, a space can be deemed qualified.

High quality of construction ensures a higher level of social interaction as well as increased social capital in such spaces. The identification of the contributing factors to the quality of such spaces can act as a foundation for the analysis of the current situation, formation for future decisions and prevention of defects in the construction of such spaces. A related study conducted back in 2003 investigated more than 1000 public spaces throughout the world. The results indicate that the most successful and



effective public spaces have 4 key qualities in common: access and linkage, sociability, uses and activities, comfort and image (PPS, 2006).

According to what was discussed concerning the quality of public spaces from the view point of contemporary scholars and experts and based on the

important qualities of Bazaar squares in the past as well as the spatial-aesthetic and functional constructs of urban spaces, the most important qualities of commercial center plazas can be summarized as follows (Theoretical Framework):

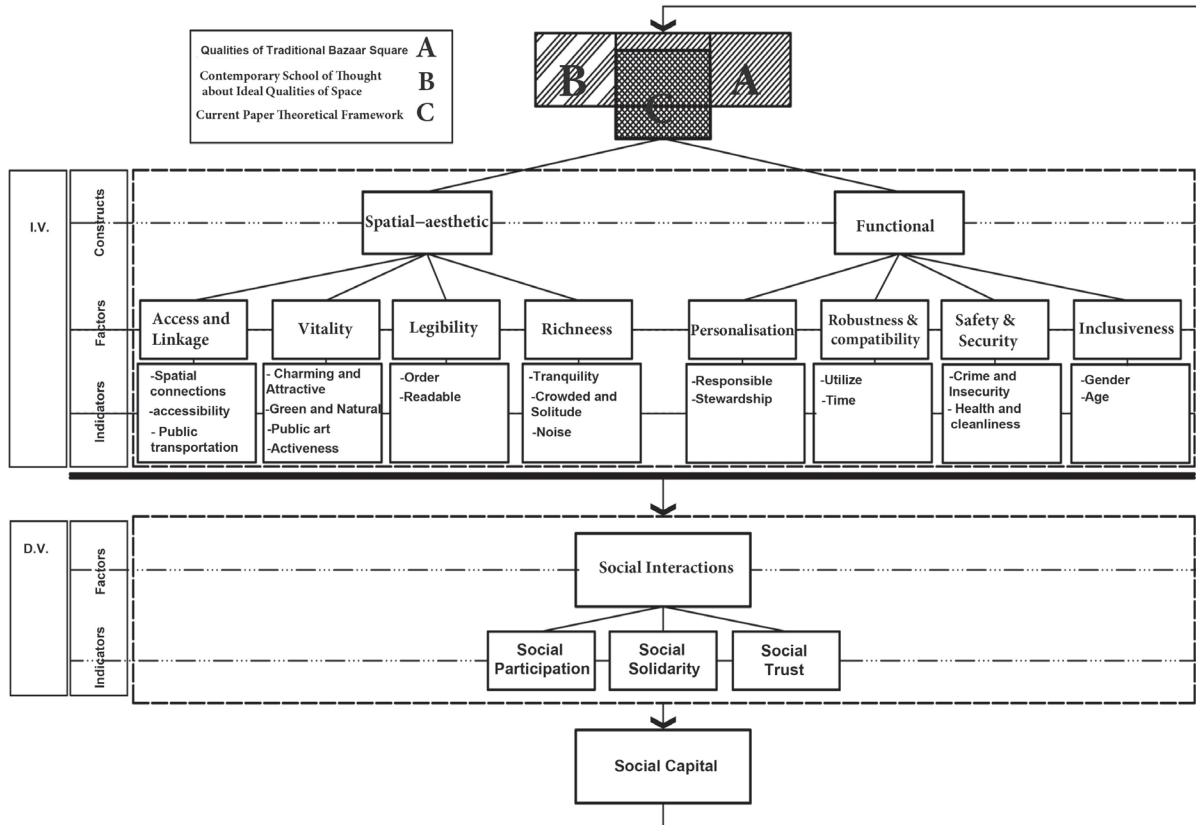

Fig. 6. Theoretical Framework of the Study

Open spaces provide citizens with freedom of movement and activity and take them out of the domain of private spaces into the public realm, “preparing the ground for public participation”. On the other hand, dominance of private spaces ignores social values, keeping citizens busy with their private lives. Passing judgment on the quality of a space should be based on the analysis of the functional concepts and the congruence of the form with social needs. Determining a social criteria and translating it in the designing process can result in the creation of a social environment compatible with the related activities. Therefore, we continue with the study

of such qualities and their effects on social interactions in the context of urban plazas in the form of two types of traditional and modern commercial centers.

## RESEARCH METHODOLOGY

The methodology adopted by this study is a mixture of qualitative and quantitative methods covering library resources (theoretical basics), human resources (citizens) and physical space resources. The research tool assisting the study is the questionnaire technique, closed questions. The process starts with the analysis of the specified criterions in the existing theoretical literature and in the





next phase the quantitative techniques are employed in order to assess the validity of the obtained results. In this regard, the process of calculating sample size utilizing for questionnaire is elaborated as below:

**Sample Size**

The calculation of the questionnaire’s sample size

carried out by G\*POWER and COCRAN (software) determined the sample size to be approximately 384. In this process 400 questionnaires were distributed in Bazar-e Reza and Proma shopping center (200 questionnaires each).

The structure of the questionnaire was based on theoretical frameworks extracted from the existing literature review on the subject (see below table).

**Table 1. Independent and Dependent Variables**

Variable	Constructs	Factors
Independent Variable	spatial-aesthetic	access and linkage Vitality Legibility Richness
	functional	Personalization Robustness and Compatibility Safety and Security Inclusiveness
Dependent Variable	Social Interactions	Social Participations Social Solidarity Social Trust

**Introducing Mashhad Metropolis (Case Study)**

With a population of approximately 2,400,000 people and an area of 30 thousand hectares, the city of Mashhad, which forms the capital of the urban agglomeration of Mashhad, is a metropolis at the national and international levels. The economic and social workings of the city are heavily influenced by its role as a pilgrimage and tourism city. Public spaces form the original context of such activities which based on the existing categories; shopping centers are among these activities. Typically, shopping centers are either indoor or outdoor, have a commercial-recreational function and belong to the private sector. Based on the conducted surveys, from the most important commercial centers of the city (Zistkhavar, Al Ghadir, Bazaar-e Reza and Proma) on the regional scale and higher, Bazaar Reza and Proma shopping center were selected for the study. The main reasons for this selection are as follows:

- Their location on the main spatial structure of the city
- They are well known landmarks for the citizens
- The possibility of making a comparison between

spaces with traditional and modern structures in the spatial structure of the city

- Presence of a diverse spectrum of visitors
- They are located at two different centers of the development process of the metropolitan city of Mashhad.

**Proma**

Proma is one of the modern shopping centers of the city which is located at one of its main squares (Ferdowsi-Janbaz junction). The internal space of this center is multi-functionally equipped (commercial-recreational) and the building has a main entrance and an exit. Despite the existence of equipped central and peripheral spaces in the shopping center, one can identify undefined and deserted spaces, in other words lost spaces (urban plaza), at the entrance of the building. There is no proper or definite bordering between the private and public spaces which does little to prevent the negative effects of the traffic outside. The sole function served by the space at the entrance of this commercial center is “transportation of goods and passengers”.



Fig. 7. Proma Shopping Center



Fig. 8. Bazaar-e Reza

### *Bazaar-e Reza*

Bazaar-e Reza is one of the most important commercial centers in Mashhad. This Bazaar has long been the communicational, economic and social axis of the city and is located adjacent to important social and cultural sites such as the holy shrine. This Bazaar has two main entrances and exits in Beytalmoghadas and 17th of Shahrivar squares which are among the city's main squares. Some measures have been taken to control vehicle traffic at the entrance spaces of the Bazaar but many problems still exist. By defining an entrance square and the proper use of the existing potentials (such as hidden spaces), social interactions and urban life have been preserved in this Bazaar. The availability of attractive functions in the vicinity of the detached plazas and the 24-hour activities which go on in the area, give a special identity to the place.

## RESULTS AND DISCUSSION

### *Analysis of the Constructs' Factors Quality in Two Selected Commercial Centers;*

In this regard, one sample T-test is used to analyze the quality of factors of two constructs (spatial- aesthetic and functional) in both Proma and Bazaar-e Reza. One sample T-test has been carried out based on the three values considered as the mean rate of audience's opinion in LIKERT Scale.

One sample statistic test of T- student is listed in the table below, indicating the significance level of the mentioned factors.

Table 2. Analysis of the Constructs' Factors Quality

First construct factors; (spatial- aesthetic)		Result	Size	t	df	Sig. (2-tailed)	Mean Difference
Proma	Access and linkage	Significant level of difference	Upper than average	-26.101	199	.000	-.63167
	Vitality	Significant level of difference	lower than average	-25.880	199	.000	-.65400
	Legibility	Significant level of difference	lower than average	-4.748	199	.000	-.13250
	Richness	Non-Significant level of difference	average	-.198	199	.843	-.00625
Bazaar-e Reza	Access and linkage	Significant level of difference	lower than average	-17.054	199	.000	-.54167
	Vitality	Significant level of difference	Upper than average	3.741	199	.000	.13200
	Legibility	Significant level of difference	Upper than average	8.758	199	.000	.30500
	Richness	Non-Significant level of difference	average	-.649	199	.517	-.02500



**Table 3. Analysis of the Constructs' Factors Quality**

Second Construct Factors; (functional)		Result	Size	t	df	Sig. (2-tailed)	Mean Difference
Proma	Inclusiveness	Significant level of difference	Higher than average	18.384	199	.000	.50625
	Safety and Security	Significant level of difference	Higher than average	8.092	199	.000	.21000
	Robustness and Compatibility	Significant level of difference	lower than average	-11.374	199	.000	-.37000
	Personalization	Significant level of difference	Higher than average	3.118	199	.002	.09500
Bazaar-e Reza	Inclusiveness	Significant level of difference	Higher than average	15.988	199	.000	.56875
	Safety and Security	Significant level of difference	Higher than average	13.923	199	.000	.52875
	Robustness and Compatibility	Significant level of difference	Higher than average	3.674	199	.000	.13500
	Personalization	Non-Significant level of difference	average	1.381	199	.169	.06125

**Table 4. Analysis of the Constructs' Factors Quality**

One-Sample Statistics				
Dependent variable (D.V.)	N	Mean	Std. Deviation	Std. Error Mean
Proma	200	2.7643	.31250	.02210
Bazaar-e Reza	200	2.9246	.45510	.03218

**Table 5. Independent Variable and Dependent Variable**

Dependent Variable (D.V.)	Result	Size	t	df	Sig. (2-tailed)	Mean Difference
Proma	Significant level of difference	lower than average	-10.667	199	.000	-.23571
Bazaar-e Reza	Significant level of difference	lower than average	-2.342	199	.020	-.07536

Based on the analysis of the one-sample T-test carried out in Bazar-e Reza and Proma commercial centers, the following interpretations can be offered:

***Spatial-Aesthetic***

Bazaar-e Reza: the results indicate that the mean of access and linkage factors are below the average and the difference level of their mean is significant. This has happened as a result of a spatial discontinuity due to the influence of modernism. With regard to the vitality and legibility factors, people believe that the presence of

this traditional square as an un-detachable urban space in bazaar-e Reza has a positive impact and the mean of vitality and legibility is more than average, indicating a significant difference. Regarding the sensorial richness factor, the audiences' opinion is close to average and the level of difference is not significant. This is due to the low spatial quality of un-detachable public space of Bazaar-e Reza.

Proma shopping center: As expected, based on the results of the literature review and field observations, the mean of access and linkage, vitality and legibility factors in spatial-aesthetic construct was below the average



which amounts to a significant difference. This is due to lack of an un-detachable public space in at the entrance of these commercial centers. It should be mentioned that the sensorial richness factor did not have a significant mean difference.

**Functional**

Bazar-e Reza: According to the result of T-test, as well, regarding to the existence of an un-detachable public space (traditional square) in the entrance of Bazar-e Reza as an alive space, except the sense of belonging the rest of factors of functional construct are known significantly by amount of mean being more than average, which is due to crowded atmosphere and the effects of modernism ideology dominants in this space.

Proma shopping center: Despite the unfavourable opinions of the people regarding the spatial-aesthetic construct of this commercial center, there were unexpected viewpoints which seem interesting. Inclusiveness, safety, security, and personalization factors were considered to be significant, while flexibility and compatibility were not considered to be among the significant factors. This is probably due to the lack of an un-detachable plaza at the entrance of this shopping center, as people approach the shopping center they are faced with a solid structure called Proma.

**Social Interactions**

Regarding D.V., it can be concluded that the level of social interactions is weak in both commercial centers

(below average with a significant difference) but it should be considered that Bazar-e Reza is in a better condition compared to Proma, It is obvious that the presence of a traditional square as an detached plaza at the Bazar-e Reza’s entrance has contributed to this betterment.

**Models**

Regarding the inferential analysis, following the one-sample T-Test carried out concerning the factors affecting social interaction in each commercial center, a Confirmatory Factor Analysis was conducted using LISREL software in order to determine the influential modelling constructs in the selected commercial centers.

**Model No. (1)**

In this model, the influential factors of spatial-aesthetic construct are modelled towards the dependent variable (D.V.) of social interactions (see Fig. 9). The output of fitting the model by influential factors (independent variables) is as follows:

**Table 6. Dependent Variable (D.V.) of Social Interactions**

A	access and linkage
D	Vitality
E	Legibility
G	Richness
D.V.	Social interactions

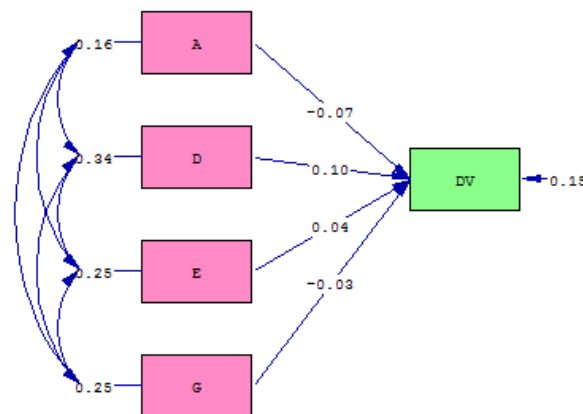

Chi-Square=2608.08, df=0, P-value=1.00000, RMSEA=0.000

**Fig. 9. Model (1)**





DV = - 0.072\*A + 0.095\*D + 0.039\*E - 0.034\*G, Error var. =0.15, R<sup>2</sup> = 0.33  
 Degrees of Freedom = 0  
 Full Information ML Chi-Square = 2608.08 (P = 1.00)  
 Root Mean Square Error of Approximation (RMSEA) = 0.0  
 90 Percent Confidence Interval for RMSEA = (0.0; 0.0)  
 P-Value for Test of Close Fit (RMSEA < 0.05) = 1.00

Considering the calculation above, RMSEA equals zero which indicates closeness of the existing model to the desired model but since the value of CHI-SQUAE is not zero, they do not fully fit the desired model (the ideal condition) despite being close (good condition). Considering the value of R<sup>2</sup>, 33% of social interactions (D.V.) are supported through spatial-aesthetic construct factors.

Given the range of the issues of social interaction (supported and influenced by many factors e.g. social, cultural, and etc.), the present article has been successful in detecting the influential factors of spatial-aesthetic construct in social interactions. It is important to note that given the low level of social interactions and the low quality of spatial-aesthetic construct's influential factors (see T-Test results) in both commercial centers, any improvements in these factors can result in an increase in

social interactions, increasing the value of R<sup>2</sup>.

**Model No. (2)**

In this model, the influential factors of functional construct are model ledafter the dependent variable (D.V.) of social interactions (see Fig. 10). The output of fitting the model by influential factors (independent variables) is as follows:

**Table 7. Independent Variable and Dependent Variable**

B	Inclusiveness
C	Safety and Security
F	Robustness and Compatibility
H	Personalization
D.V.	Social interactions

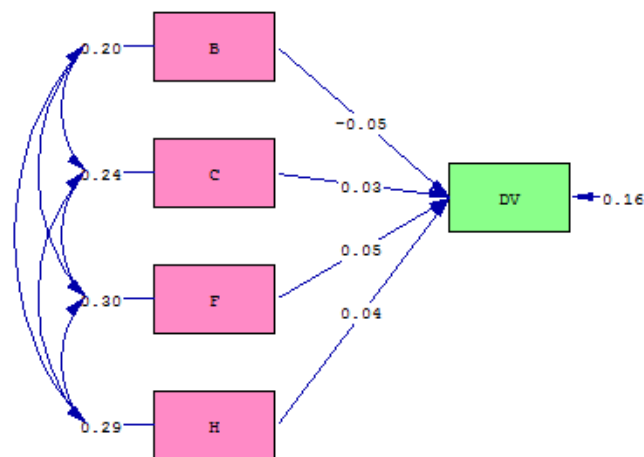

Chi-Square=2719.05, df=0, P-value=1.00000, RMSEA=0.000

**Fig. 10. model (2)**



DV = - 0.050\*B + 0.026\*C + 0.054\*F + 0.039\*H, Error var. =0.16, R<sup>2</sup> = 0.13  
 Degrees of Freedom = 0  
 Full Information ML Chi-Square = 2719.05 (P = 1.00)  
 Root Mean Square Error of Approximation (RMSEA) = 0.0  
 90 Percent Confidence Interval for RMSEA = (0.0; 0.0)  
 P-Value for Test of Close Fit (RMSEA < 0.05) = 1.00

According to the calculation above, RMSEA equals zero which indicates the existing model is a close fit to the desired model but since the value of CHI-SQUAE is not zero, therefore, it doesn't fully fit the desired model (the ideal condition), despite being a close fit (good condition). Considering the value of R<sup>2</sup>, 13% of the existing social interactions (D.V.) are supported through the influential factors of the functional construct.

Given the range of the issues in social interaction, which is supported and influenced by factors such as society or culture, the present article has been successful in determining the influential factors of the functional construct in social interactions. It is important to note that given the low level of social interactions and the low quality of functional construct's influential factors (see

t-test results) in both commercial centers, any increase in the impact of these factors will result in the increase of social interactions, resulting in the increase of the value of R<sup>2</sup>.

**Model No. 3**

In the final model, which is structured based on the integration of the afore mentioned constructs (spatial-aesthetic and functional), RMSEA equals zero which indicates the existing model is a close fit to the desired model. Compared to the three existing models, this model has the closest to the desired model in terms of the contribution of the independent variables (8 influential factors) of the study in the dependent variables (R<sup>2</sup>:0.41).

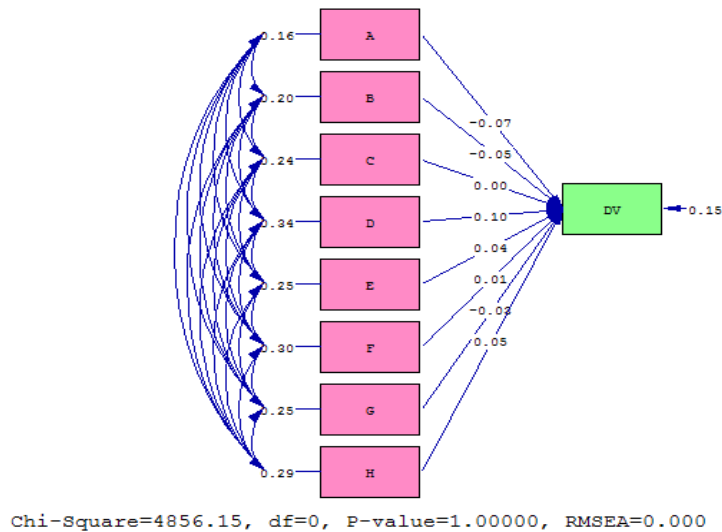

Fig. 11. Model (3)

DV = - 0.065\*A - 0.051\*B + 0.0018\*C + 0.096\*D + 0.041\*E + 0.014\*F - 0.031\*G + 0.047\*H, Error var. =0.15, R<sup>2</sup> = 0.41  
 Degrees of Freedom = 0  
 Full Information ML Chi-Square = 4856.15 (P = 1.00)  
 Root Mean Square Error of Approximation (RMSEA) = 0.0  
 90 Percent Confidence Interval for RMSEA = (0.0; 0.0)  
 P-Value for Test of Close Fit (RMSEA < 0.05) = 1.00



Given the range of the issue of social interaction which is supported and influenced by factors such as society or culture, the present article has been successful in determining the influential factors of the functional construct in social interactions.

It is important to note that given the low level of social interactions and the low quality of functional construct's influential factors (see t-test results) in both commercial centers, any increase in the impact of these factors will result in the increase of social interactions, resulting in the increase of the value of  $R^2$ .

A scrutinizing look at the models 1 and 2 reveals that from the people's point of view, the share of the spatial-aesthetic construct is higher in the fitting model, compared to functional constructs. This in itself highlights the role of undetectable plazas, as emphasised throughout the article, in commercial centers for the purpose of meeting the spatial and aesthetic demands of the people, today.

## CONCLUSION

The analysis of un-detached squares in traditional and modern commercial centers revealed that citizens give priority to spatial and aesthetic features, compared to functional features.

The results of the study indicate that the secret of the success of such places is that, there are influential factors composing both spatial-aesthetic and functional constructs. In this regard, vitality, access and linkage, legibility, and richness in turn are among the important spatial-aesthetic factors. Regarding the functional construct, the factors in need of more quality improvement include inclusiveness, personalization, robustness - compatibility, and safety - security.

All things considered, it can be claimed that from the customers' perspective, the presence of un-detached plazas at the entrance of commercial centers is most beneficial; it can lead to an increase in the level of social interaction and as a result social capital. In the case of Bazar-e Reza which includes a traditional square in its structure, customers were more concerned with the aesthetic elements of the building, whereas in the case of Proma which is built without a un-detached urban space at the entrance, suggestions for improvement were mainly centered on both aesthetic and functional elements.

Finally, considering that the outputs of the inferential statistic, extracted theory from the literature, fit the final model, the important conclusion can be made that the improvement of the two mentioned factors and their sub-factors in un-detached commercial spaces is an

opportunity for the strengthening of social interactions of citizen.

Finally, it can be concluded that with a good understanding of the importance of un-detached open spaces and squares in commercial centers (especially bazaars), traditional urbanization benefited from them as arenas for the manifestation of the social life of the city. In this regard, the design and construction of these un-detached urban squares were carried out with a special consideration for economic values, social life and spatial elements. Therefore, the revival of such spaces with new spatial forms (un-detached urban plazas) in modern shopping centers, along with proper aesthetic and functional elements and their related factors can lay the foundation for the improvement of the level of social interaction in cities.



## REFERENCES

- Ardalan, N. & bakhtiyar, I. (1999). *The Sense of Unity: The Sufi Tradition in Persian Architecture*, USA: ABC International Group.
- Bullen, P. Onyx, J. (1998). *Measuring Social Capital in Five Communities in New South Wales: Paul Bullen and Jenny Onyx with Neighbourhood and Community Centres*. (2012.3.16), URL: <http://www.mapl.com.au>.
- Bardianamoradnejad, R. (2011). *An Introduction to Urban Squares*. Sari: Mazandaran University Publisher.
- Bentley, I. & alan. Murrain, P. McGlynn, S. Smit, G. (2008). *Responsive Environments: A Manual for Designers*. London: the Architectural Press.
- Canter, D. (1977). *The Psychology of Place*. London: Architectural Press.
- Carmona, M. (2011). *The Design Dimension of Planning: Theory, Content and Best Practice for Design Policies*. London: Taylor & Francis Group.
- Carmona, M., Heath, T., Oc, T. & Tiesdell, S. (2010). *Public Places - Urban Spaces*. London: Architectural Press.
- Cooper, M., Carolyn, F. (2008). *People places: design guidelines for urban open space*. London: VanNostrandReinhold.
- Cooper, M. & Sarkissian, W. (1997). *Housing as if People Mattered*. Berkeley: University of California Press
- Cullen, G. (2012). *Concise Townscape*. London: Taylor & Francis
- Falamaki, M. (2005). *Experience of Urban Restoration: from Shiraz to Venice*. Tehran: Faza Publisher.
- Goodsell, Ch. (2008). THE CONCEPT OF PUBLIC SPACE AND ITS DEMOCRATIC MANIFESTATIONS. *Journal of Planning Education and Research*, No 27, 382-399.
- Homans, G. C. (1974). *Social Behaviour: Its Elementary Forms*. New Jersey: Rutgers.
- Habibi, M. (2012). *From Precity to City*. Tehran: Tehran University Press.
- Jacobs, J. (1992). *The Death and Life of Great American Cities*. New York: Knopf Doubleday Publishing Group.
- Lynch, K. (1993). *The Image of the City*. Cambridge: MIT Press
- Madanipour, A. (1996). *Design of Urban Space: An Inquiry into a Socio-Spatial Process*. London: John Wiley & Sons Publisher.
- Movahed, A. (2005). *Restoration of Traditional Bazaars*. Isfahan: National Conferences Desert Architecture.
- Miller, M. (1998). *Shopping, Place and Identity*. London: Routledge.
- Naghizadeh, M. (2010). *Analysis and Design of Urban Space*. Tehran: Jahad University Publisher.
- Norberg-Schulz, C. (2000). *Architecture: Presence, Language, and Place*. London: Skira.
- Pakzad, J. (2007). *Guideline Urban Space Design*. Tehran: Shahidi Publisher.
- Punter, J. V. (1991). *Participation in the Design of Urban Space*, Landscape Design, Vol 200.
- Project for Public Spaces. (2006). *SPACE INTO THE PLACE: Using Public Spaces to Rebuild Communities*. (2012.3.25). URL: <http://www.PPS.org/>
- Soltanzadeh, H. (2007). *Iranian Bazaars*. Tehran: Culture Research Bureau Municipality of Tehran.
- Soltanzadeh, H. (2010). *Urban Spaces in the Historical Texture of Iran*. Tehran: Culture Research Bureau Municipality of Tehran.
- Sorkin, M. (2011). *All Over the Map: Writing on Buildings and Cities*. New York: Verso.
- Steele, F. (2007). *the Sense of Place*. Boston: CBI Publishing Company.
- Trancik, R. (1986). *Finding Lost Space: Theories of Urban Design*. Ithaca: Cornell University.
- Venturi, R. (2008). *Learning from Las Vegas*. London: Routledge.
- Whyte, W. H. (2001). *The Social Life of Small Urban Spaces*. New York: Project for Public Spaces Incorporated.